

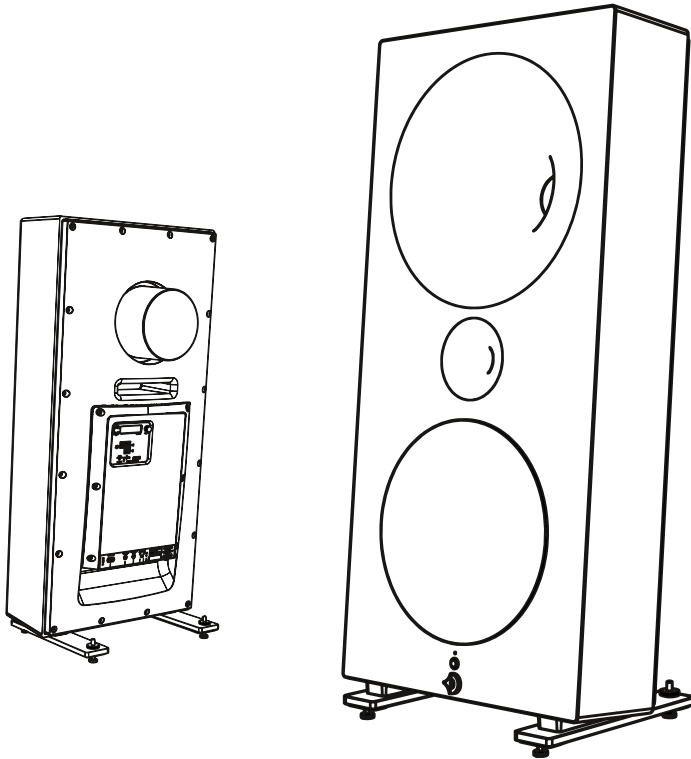

avantgarde
ACOUSTIC



User Manual

ZERO ITRON

Version 1.1

TABLE OF CONTENTS

<u>SAFETY INFORMATION</u>	
SAFETY INFORMATION	4
PRECAUTIONS ON INSTALLATION	5
OPERATING VOLTAGE	5
<u>SET UP</u>	
CONTENT OF PACKAGES	6
UNPACKING	7
SPEAKER STAND ASSEMBLY	7
SPIKE ASSEMBLY	8
<u>OPERATION</u>	
SAFETY PRECAUTIONS	10
CONNECTION ITRON VERSION – BALANCED XLR	11
POWER SWITCH	11
SPEAKER GAIN SETTINGS	12
POWER MODE SETTINGS	13
<u>OPERATION DSP SUBWOOFER AMP</u>	
SUBWOOFER VOLUME	14
DSP SOFTWARE INSTALLATION	15
DSP USER INTERFACE	16
DSP SETTINGS	17
<u>FINE TUNING</u>	
ROOM PLACEMENT	18
TOE-IN & TOE-OUT	19
TILTING	20
RUN IN TIME	20
WARM-UP TIME	20
<u>MISCELLANEOUS</u>	
12V DC TRIGGER	20
CLEANING	21
SPEAKER REGISTRATION	23
WARRANTY	24–25
NOTES	26–27
CONTACT ADDRESS	28



SAFETY INFORMATION

CAUTION



To prevent fire, shock or damage, do not expose the components to rain or moisture.



Conditions for operation:

room temperature 5 – 35° C,
humidity 10 – 75%



It is intended to alert the user of the presence of uninsulated "dangerous voltage" within the products enclosure. To avoid electrical shock, do not open the cabinet of the components.



Excessive sound pressure levels might cause serious damage to your health. Do not turn up the volume of the loudspeaker system to loud!



Should any solid object or liquid fall into the cabinet of the components, unplug the unit and have it checked by qualified personnel before operating it any further.



Unplug the components of your system from the wall outlet and antenna if they are not to be used for an extended period of time. To disconnect the power cord, always pull on the plug and never on the cord directly. Never touch the plugs with wet hands.



Only have the system installed and repaired by authorized personnel.

PRIVATE USE ONLY

These loudspeakers are designed for the playback of audio signals. Any misuse, especially commercial operation, will invalidate the warranty.



SAFETY INFORMATION

PRECAUTIONS ON INSTALLATION

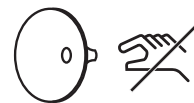

Do not carry the speakers by the horn.

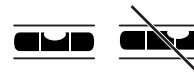

Place the loudspeaker on a flat floor with a load-bearing capacity that adequately supports the weight of the loudspeakers.



To prevent internal heat build-up in the components, place units in a location with sufficient air circulation. Do not install the speakers in a location near heat sources, or in a place subject to direct sunlight, excessive dust, or mechanical vibration.



Connect everything securely. Always insert the cables and plugs fully into the jacks. A loose connection may cause hum pick-up and can damage the system. Use only high-quality cables with self-tightening banana speaker and RCA or XLR plugs.

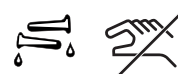

To avoid damaging the finish, never use alcohol, paint thinner or aggressive cleaners to clean the components.



Read this operators manual thoroughly before operating the speaker system.

OPERATING VOLTAGE



The amplifier can be powered from main voltages of 90 – 250 volts with a mains frequency of 50-60 Hz.

CONTENT OF PACKAGES

ZERO ITRON

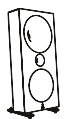

2 x cardboard boxes with one speaker in each.

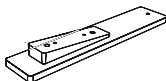

4 x Speaker stand

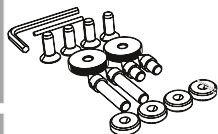

4 x stainless steel spikes short (part no. AA13006)

4 x stainless steel spikes long (part no. AA13005)

8 x protective discs (with center recess) for the spikes, to protect sensitive floors. (part no. AA13041)

4 x stainless steel knurled M8 nuts. (part no. AA13006)

4 x plastic washer, M8. (part no. AA0459)

8 x Countersunk screw, M8x20. (part no. AA1089)

1 x Allen key (wrench size 5) to adjust the lock nuts, equipment feet & spikes. (part no. AA1414)

1 x Small pin tool for spike. (part no. AA12483)



2 x power cables



1 x user manual

UNPACKING & SPEAKER STAND ASSEMBLY

ZERO ITRON



When unpacking and setting up the speaker, be aware of their heavy weight! For this work we strongly recommend the assistance of one person!

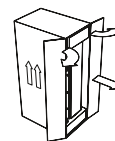

① Place the packaging carton upright, remove the clips and open the carton.

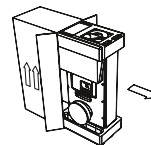

② Carefully pull the loudspeaker forward.

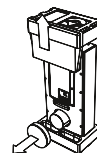

③ Remove the upper EPP packaging protection and the accessory boxes.



④ Assemble the speaker stands using 4 x countersunk screws, (M8x20) & the allen key.

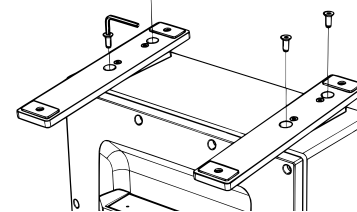

⑤ Carefully lift the speaker to its upright position.

ASSEMBLY OF SPIKES

ZERO ITRON



When unpacking and setting up the speaker, be aware of their heavy weight! For this work we strongly recommend the assistance of one person!

- ① Carefully tilt the loudspeaker backward when installing the **front 2 x spikes** (short).
- ② Screw the spikes into the thread from the underside and tighten using the small pin tool. If necessary, use the protective discs to protect sensitive floors from damage.

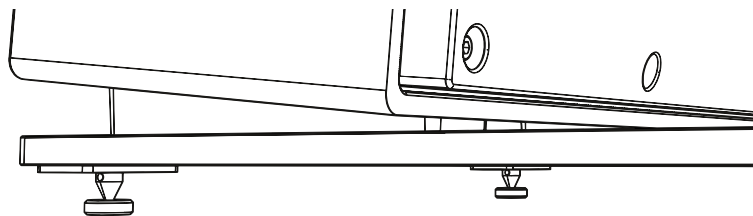

- ③ Carefully tilt the loudspeaker forward when installing the **rear 2 x spikes** (long).
- ④ Screw the spikes into the thread from the underside to the desired height using the small pin tool.
- ⑤ Fit the plastic washer (red) and tighten the spike with the stainless steel knurled nuts (M8). If necessary, use the protective discs to protect sensitive floors from damage.

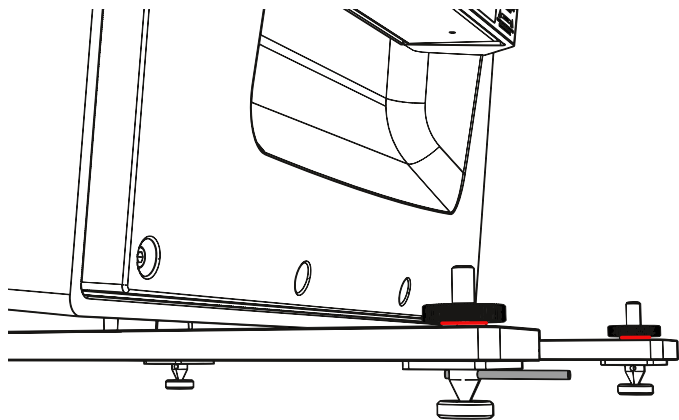

SAFETY PRECAUTIONS

ON INSTALLATION



The power to all components must be switched "off" (or disconnected from the household AC) before making any audio connections.



To prevent malfunction/defects, never operate components with unassigned input sockets (unwired)!

The signal connections are located on the underside of the amplifier module on the back of the speaker.

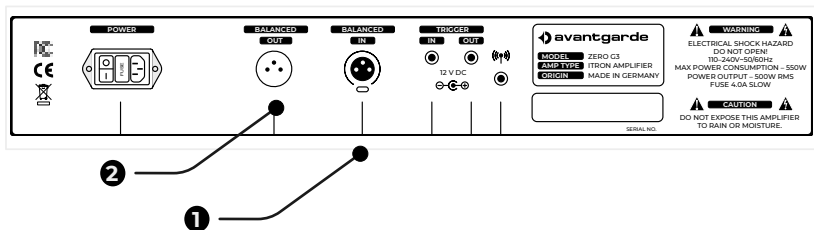
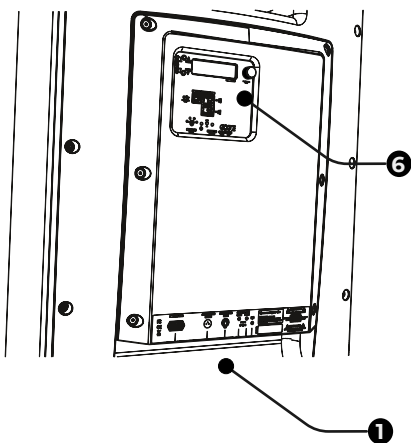

CONNECTION

BALANCED XLR CONNECTION



Line level connections feature balanced XLR connectors/terminals. The pin assignment of these follows the EIA RS-297-A standard: PIN 1 = GND, PIN 2 = HOT, PIN 3 = COLD. Never use cables with differing pin assignment! This will deteriorate the sound quality and can damage the amplifiers and/or the active power modules of the subwoofers.

- 1 Connect the line level output of your preamplifier to the balanced BALANCED-IN input 1 of the loudspeaker using an XLR cable.

The BALANCED-OUT output 2 can be used to connect additional subwoofers.

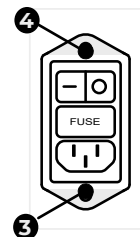

- 2 Only now, connect the AC power 3 of the components to a household AC outlet and turn on the loudspeaker 4.

The power switch 4 has an "O" OFF position and a "I" ON position. Switch it to the ON position for operation.

POWER SWITCH

TOGGLE BETWEEN ON & STANDBY

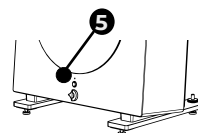

There is a push button 5 on the front of the loudspeaker to switch the loudspeaker ON or to STANDBY.



When the device is powered on, the LED indicator illuminates white, and in standby mode, it turns orange. The DIMMER TOGGLE button on the DSP control panel 6 allows to switch the brightness of the LED between 8 x intensities.

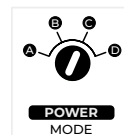

The POWER-ON mode switch on the DSP control panel 6 allows to select 4 different power ON/OFF modes. See description on the POWER MODE SELECTION.

SPEAKER GAIN SETTINGS

AUDIO SOUND ADJUSTMENTS

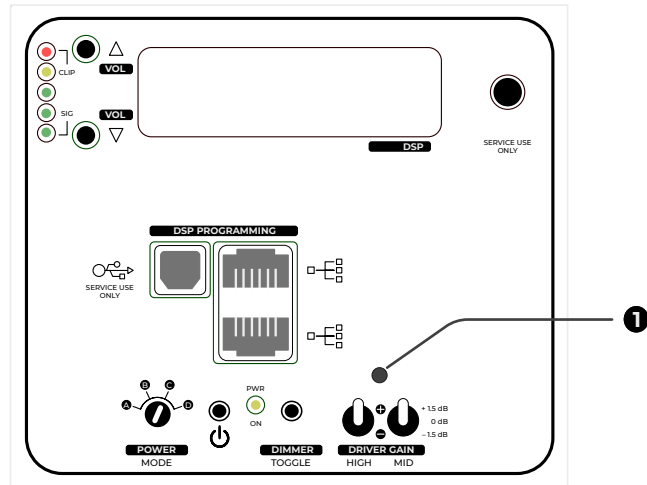

The two DRIVER GAIN switches ❶ allow the volume of the two horns to be adjusted in -1.5 dB, 0 dB (= linear) and +1.5 dB steps.

MID controls the level of the midrange horn (approx. 250–4,000 Hz)
HIGH controls the level of the high frequency horn (above 4,000 Hz)

The factory setting is the "0 dB" position for both switches.

Adjustments can be made according to personal taste, to match the tonal "tonality" of the connected source equipment, or to slightly correct for room acoustic influences.

In practice, the tonal balance between the 2 x frequency bands can be changed by up to 3 dB. Example:

If the HIGH switch is set to +1.5 dB and the MID switch is set to -1.5 dB, the relative loudness of the midrange speaker compared to the tweeter horn is reduced by 3 dB. This could be used as a beneficial voicing for "shrill" recordings (with overemphasized midrange) or in an acoustic environment with a "peak" in the midrange.

POWER MODE SETTINGS

MANUAL OR AUTO POWER-ON

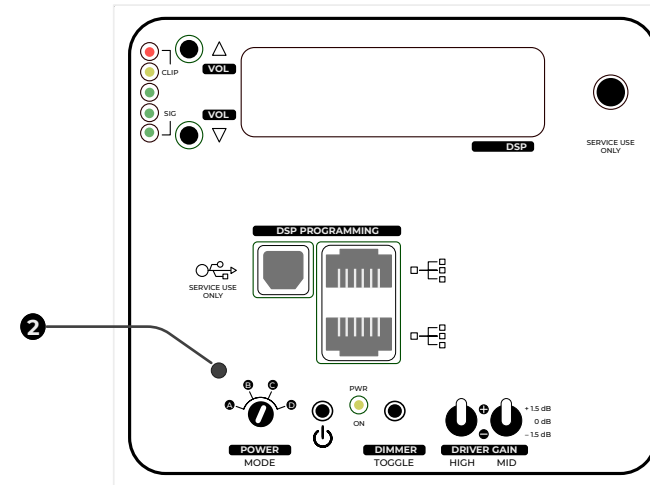

POWER MODE SWITCH

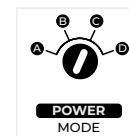

4 x different power ON/OFF modes can be selected with the POWER MODE selector ❷. Use a screwdriver to switch modes.

MODE A speaker is ON upon powering it up with the mains power switch. To be used e.g. for remote controlled AC power sockets.

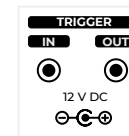

MODE B speaker is ON when a 12VDC trigger voltage is detected at the remote-trigger socket. The speaker will automatically switch OFF, when the 12V trigger voltage is switched OFF.

MODE C the push button on the front of the loudspeaker is used to toggle between ON & STANDBY.

MODE D The speaker switches on automatically when a music signal is detected. After 20 minutes without a signal, the device automatically switches to standby mode.

☛ In MODE A & MODE D, the device can also be switched on manually using the push button on the front (see MODE C).

SUBWOOFER VOLUME

DSP VOLUME SETTINGS

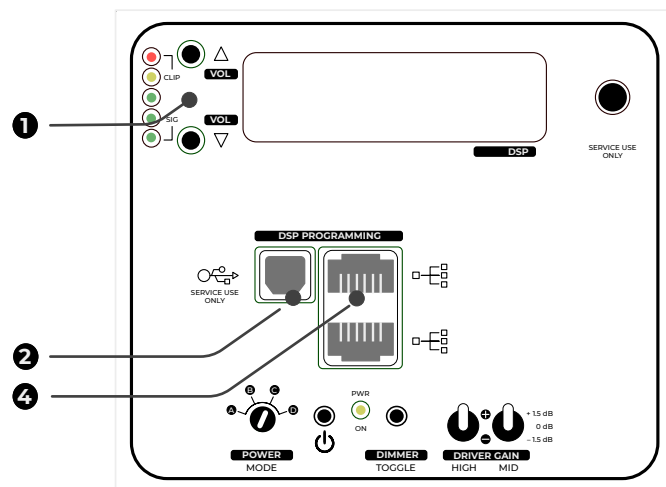

The bass response of the speaker will be influenced by the room and the position of the speaker. This might cause the bass response of the speaker to be strengthened or weakened. Thus as the first step, the overall bass volume needs to be aligned to compensate these effects.

- 1 Press the VOL ▲-button 1 to increase or the VOL ▼-button 1 to reduce the volume of the bass response. The set volume is indicated in the display.

SUBWOOFER PROGRAMMING

DSP SOFTWARE INSTALLATION



Additional settings can be programmed with the Avantgarde Control software.

The corresponding software, for Windows and MacOS can be downloaded from the website: www.avantgarde-acoustic.de

LAN CONNECTION TO PC

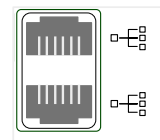

- 1 Each loudspeaker features 2 x LAN sockets which allow daisy-chaining of multiple subwoofers via LAN cable..
- 2 Connect the LAN ports 4 of all loudspeakers with each other using LAN-cable (type CAT5/6/7/8).
- 3 Connect a free LAN port 4 of one loudspeaker with the LAN port of your computer or with the LAN port of your WIFI router. The Avantgarde Control software installed on your computer/laptop will automatically detect and display all available subwoofer amps.

USB CONNECTION TO PC



USB port 2 is reserved exclusively for service application by the manufacturer.

IMPORTANT!



The LAN and the USB connectors are not suitable for the connection of music sources!

OPERATION – SUBWOOFER DSP AMP

DSP USER INTERFACE

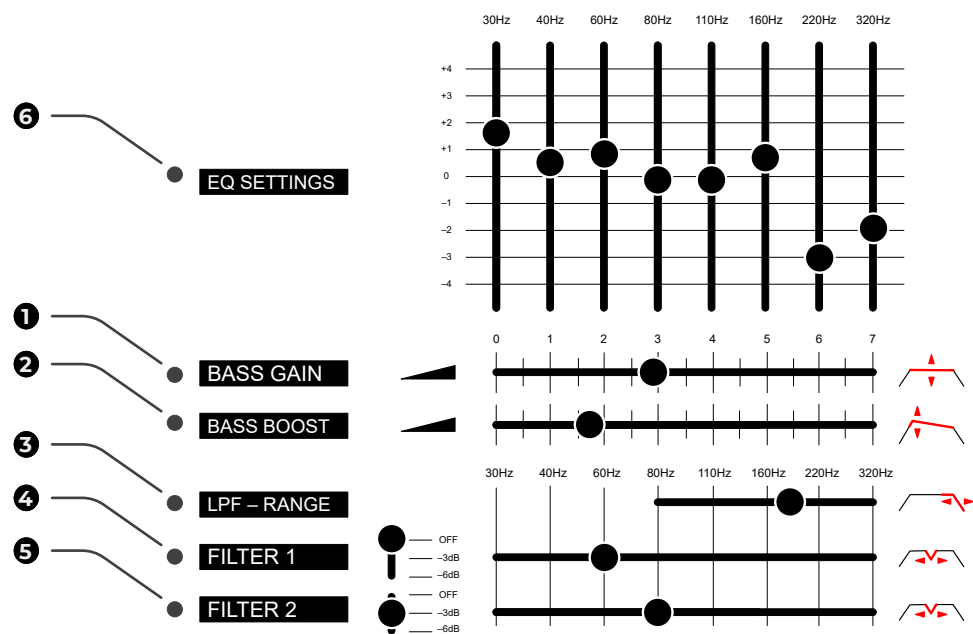

The above picture shows the graphical user interface that is available for each of the subwoofers individually after installing and starting the software.

⚠ Please note that all changes in the Avantgarde control software immediately become audible in the speaker. This way it is easy to verify the changes by listening and fine adjust if required.

OPERATION – SUBWOOFER DSP AMP

DSP SETTINGS

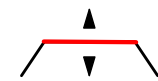

The BASS GAIN slider ❶ sets the overall volume of the subwoofer.



The BASS BOOST slider ❷ increases the low frequency response below 45 Hz. This allows to tailor the bass response from “linear” to “fat”.



For individual frequency settings use the 8 x band equalizer ❸. Each of the 8 x bands can be increased or decreased by up to 4dB. This can be used to tailor your bass response to specific sounds (linear, techno, disco, pop, etc.) or to reduce some wide-band room resonances.

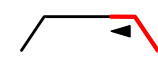

The LPF-RANGE slider ❹ sets the upper crossover frequency of the subwoofer. In the factory setting the crossover frequency is optimized for a linear transition, the frequency response of the subwoofer blends seamlessly into the frequency response of the midrange horn. The crossover frequency can be used to adjust the “tonal balance” of the system.

- ❶ When set to a higher frequency, the subwoofer will partly overlap with the midrange horn response. This will add “warmth” and give a richer “body” to the sound character of certain voices and instruments.
- ❷ If the crossover frequency is purposely set to a lower frequency, subwoofer and midrange frequency response will have a small gap. The tonal balance of the system will shift to a more horn typical “dynamic” and “punchy” sound.



FILTER 1 & 2 ❺❻ are narrow band “notch” filters with a negative gain of -3dB or -6dB. These filters can be used to eliminate/reduce unwanted narrow band resonance frequencies of the room.

- ❶ Use commonly available frequency sweep apps to detect the position (Hz) of possibly occurring room resonances. Or play bass heavy music through your system and slowly slide the FILTER set at -6dB upwards until the “boominess” improves.

FINE TUNING

ROOM PLACEMENT

We recommend to place both speakers with the horns facing towards the listener. This setup projects the high-frequency and imaging precision with maximum stability into the center of the room or in the direction of the ideal listening position.

Due to the controlled dispersion characteristics of the horns the speaker will excite significantly less unwanted reflections from the room walls compared to conventional speakers. Thus they can be positioned closely to back walls or corners (both or only one speaker in the corner!).

Choose a position for the speakers in your listening room. Both speakers and your listening seat should form an approx. equilateral triangle. Ideally each side of the triangle should be approx. 3,0 – 4,0m.

The speakers should be toed-in with the horns pointing directly to the listening position.

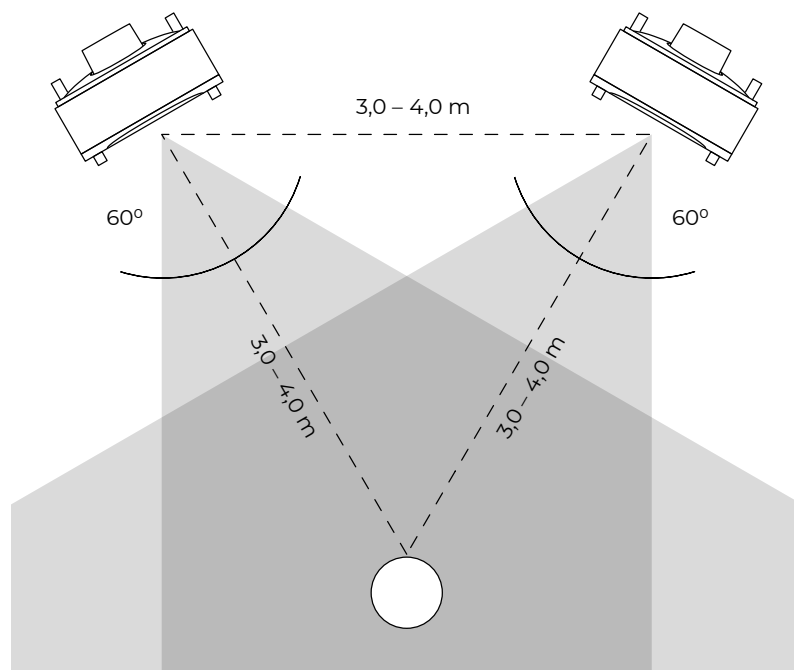

FINE TUNING

TOE-IN & TOE OUT

By facing the speakers inwards (toeing-in) or outwards (toeing-out) you can further affect the focus and tonal balance of the system.

By toeing-out, the sound appears to be less “direct” or “forward sounding”, but this may affect the focus of the centre image.

Toeing-in emphasizes increased focus on the centre image, but may affect the width of the stereo image.

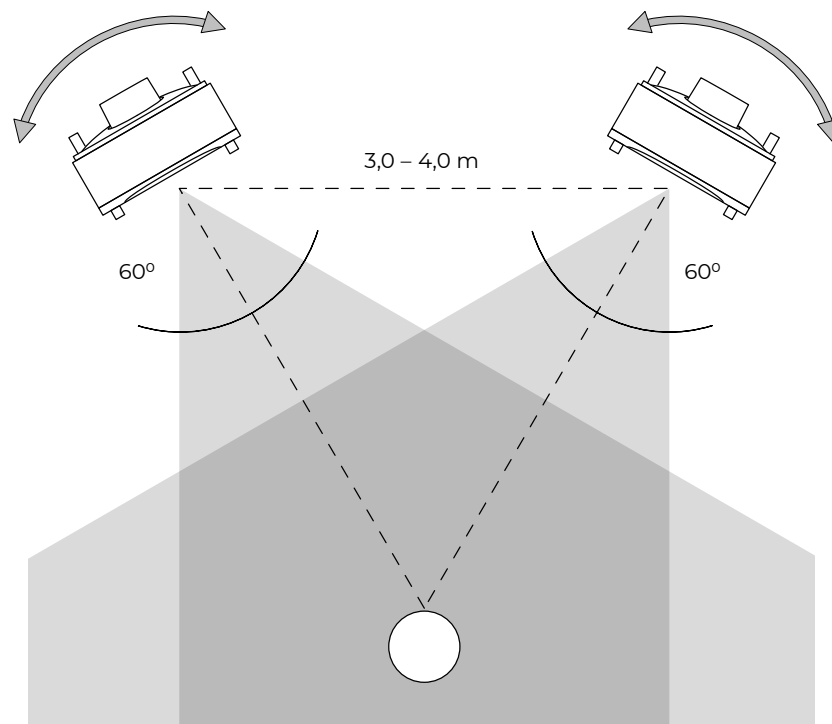

FINE TUNING

TILTING

Depending on the listening distance and seat height, it may be important to tilt the speaker systems forward or backward.

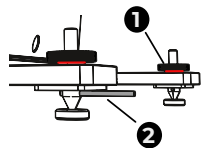

Untighten the knurled nuts ❶ by screwing them counterclockwise. Using the small pin tool ❷, screw the spike to the desired height. Tighten the knurled nuts by screwing them clockwise.

RUN-IN TIME

Brand new speakers usually need at least 40 hours of running-in. During this period sound quality will improve continuously. Leave the speakers ON during this run-in period.

After this run-in, the sound might have been altered and it might be necessary to slightly re-tune the system set-up (positioning and subwoofer-settings).

WARM-UP TIME FOR ITRON

The ITRON electronics uses pure CLASS-A circuits with Zero-Feedback. To reach its full sonic potential the components need to be fully warmed-up. A sufficient warm up time (> 15 minutes) prior to serious listening is recommended.

MISCELLANEOUS

12V DC TRIGGER

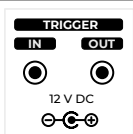

The 12V DC TRIGGER sockets of the electronics features an "IN"-socket and an "OUT"-socket. This way it is easily possible to remotely switch ON/OFF additional devices by simply daisy-chain the 12V trigger signal.

Wiring can be made with mono or stereo jack cables.

CLEANING

CLEANING OF SATIN-FINISHED LACQUER SURFACES



We recommend to regularly clean satin finished color-coated surfaces (for ex. speaker body) with a dry soft fabric (duster) or a soft brush.

To remove finger prints and dirty spots we recommend the use of glass detergent.

- Do not use waxes or polisher!
- To remove minor scratches, please contact your audio dealer, who may provide you with a touch-up kit.

CLEANING OF METAL SURFACES

Clean the powder coated & anodized surfaces of the metal parts with a regular duster or slightly moisted (i.e. by glass detergent) piece of cloth.

WARRANTY

SPEAKER REGISTRATION

Register your speaker and receive an extension of your factory warranties for 1 year at a time as the first owner.

- ① Please fill out the warranty card:

name:

street:

city:

serial no.

serial no. subwoofer

purchase date:

dealer:

- ② Take a photo of the completed warranty card with your cell phone.
- ③ Send the photo by mail using the QR code to:
"info@avantgarde-acoustic.de"



WARRANTY

Avantgarde Acoustic Lautsprechersysteme GmbH warrants that the products are free from defects attributable to faulty manufacture. The warranty is limited to ten (10) years for the stability of the connecting elements (between metal, wood and plastic parts, including the horns), five (5) years for the color coating and the drivers, and two (2) years for all electronic components.

All products Avantgarde Acoustic have been thoroughly checked before shipping. In the case of problems, please check the following:

1. This warranty begins on the date of original purchase and may be enforced only by the original purchaser. Please keep the original dated sales slip as proof of warranty coverage. The warranty period is not effected by warranty services provided within the warranty period.

2. Except as specified below, this warranty covers all defects in material and workmanship in this product. Our liability for any defective product is limited to repair or replacement of the products, at our option. Any implied warranties, including warranties of merchantabilities and fitness for a particular purpose, or damages based upon inconvenience, loss of use of the product, or commercial loss, or any other damages are not covered by this warranty.

3. Any modification, alterations or changes to the product are strictly prohibited.

4. In case of defects, please contact at first your dealer. If at the sole descretion of Avantgarde Acoustic it is necessary to ship the product to the manufacturer, please make sure that:

- The product is carefully packed and shipped in its original shipping box.
- The Avantgarde Acoustic warranty card is filled out and added to the product or, alternatively the original invoice from the dealer or a proof of online product registration in the Avantgarde Customer Club.
- The product is shipped free of charge to us, e.g. you must pay all shipping charges (ex. Freight, insurance etc.).

WARRANTY

5. The following are not covered by this warranty:

- Regular inspections, tuning, repairs or replacement of parts which are attributable to normal wear and tear.
- Damage occurring during shipment of the product. All transport claims must be presented to the carrier.
- Damages or scratches on the surface of the product (ex. Housing, horns, metal parts, color coating etc.). These claims must be presented within 3 days after the date of original purchase with your dealer.
- Damage resulting from incorrect placement, faulty connections, improper operation. Damage resulting from failure to follow instructions supplied with the product.
- Damage resulting from accident, misuse, abuse, neglect, electrical surges, lightning or other acts of God.
- Damage resulting from repair or attempted repair by anyone other than Avantgarde Acoustic or an authorized Avantgarde Acoustic dealer.
- Consequential, secondary or subsequent damages to other third party appliances.

6. Some states do not allow limitations on how long an implied warranty lasts and/or do not allow the exclusion or limitation of incidental or consequential damages, so the above limitations may not apply to you.

7. Register your new speaker on our website and receive an extension of your factory warranties by 1 year (first owner only).

www.avantgarde-acoustic.de

Avantgarde Acoustic Lautsprechersysteme GmbH
Nibelungenstr. 349
64686 Lautertal - Reichenbach
Germany



Avantgarde Acoustic GmbH
Nibelungenstrasse 349
D-64686 Lautertal
Germany

Tel: +49.6254.306 100
email: info@avantgarde-acoustic.de
www.avantgarde-acoustic.de